

Vitrinen / Vitrines / Vetrine

Mod. BERBOX

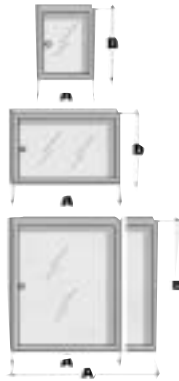

Art.Nr.	AxB	
40-121.52	290x370	218.-
40-122.52	550x370	269.-
40-123.52	550x690	341.-
40-124.52	750x690	468.-

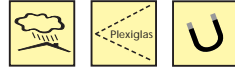

Briefkasten-Überdachungen / Abris pour boîtes aux lettres Copertura per cassette delle lettere

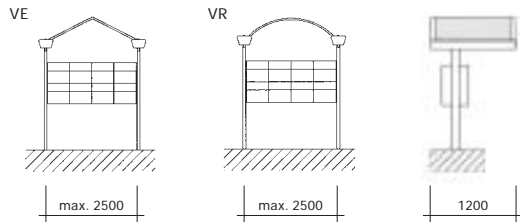
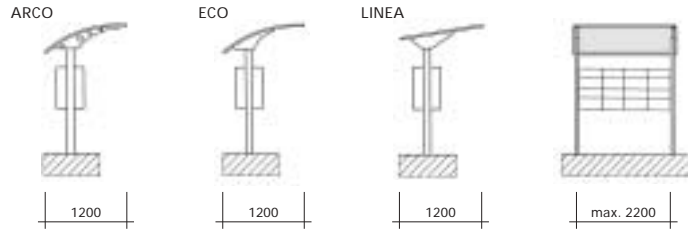

Mod. ARCO	1660.-
Mod. ECO	1560.-
Mod. LINEA	1490.-
Mod. VE	1750.-
Mod. VR	1750.-

BERBOX 11/2007

Via Argine 3 - Zona industriale 1 - CH 6930 Bedano
Tel. ++41 (0)91 935 40 50 - Fax ++41 (0)91 935 40 55
www.europrodotti.ch - E-mail: info@europrodotti.ch

EUROPRODOTTI⁺
MARINO BERNASCONI SA

Briefkasten Boîtes aux lettres Cassette per lettere

1/2007



NORM
PTT
NORM



1. Aussenmantel in Blech ALU 10/10 für Einzelkästen und 20/10 für Gruppen. Innen in galvanisch verzinktem Stahlblech.
2. Briefeinwurf 250x25 mm, Einwurfklappe mit Rückzugsfeder, nach innen öffnend.
3. Verchromter Messing-Zylinder, mit zwei nummerierten Schlüsseln, Einbaumöglichkeit für **Kaba**-Zylinder.
4. Namensschild in zweifarbigen PVC, geeignet für Gravierung.
5. Flügelverschluss.
6. Türen in ALU ab 20/10. Seitliche Öffnung.
7. Rahmen in schwarzem stossfestem ABS.
8. Abnehmbare im Schadensfall austauschbare Türen.

1. Couverture externe en tôle ALU 10/10 pour les boîtes individuelles et 20/10 pour les groupes de boîtes.
2. Ouverture d'introduction courrier 250x25. Plaque avec renvoi à ressort, ouvrable vers l'intérieur.
3. Cylindre de fermeture en laiton chromé numéroté avec deux clefs. Possibilité d'introduire directement un cylindre **Kaba**.
4. Support pour nom avec plaque PVC bicolore, indiqué pour gravures avec pantographe.
5. Fermeture à papillon.
6. Porte en ALU 20/10 avec charnière latérale.
7. Chassis en ABS anti-choc noir.
8. Charnières désenfilables, possibilité de changer la porte en cas d'endommagement.

1. Mantello esterno in lamiera ALU 10/10 per le cassette singole e 20/10 per i gruppi. Internamente in ACCIAIO elettrozincato.
2. Impostazione 250x25. Placca con ritorno a molla, apribile verso l'interno.
3. Cilindro ottone cromato, numerato con due chiavi. Possibilità di inserimento diretto di cilindro **Kaba**.
4. Portanome con targhetta in PVC bicolore, adatta per incisione a pantografo.
5. Serratura a farfalla.
6. Porte in ALU da 20/20. Apertura a libro.
7. Telaio in ABS da 20/10 antiurto nero.
8. Cerniere sfilabili, possibilità di sostituire le porte in caso di danneggiamento.

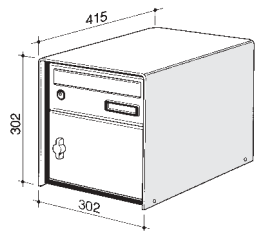

Mod. 38-272.72
Türen ALU natur und Verkleidung ALU natur
Porte ALU au naturel et revêtement en ALU au naturel
Porte ALU naturale e rivestimento ALU naturale
Mod. 38-272.76
Türen ALU natur und Verkleidung ALU schwarz lackiert
Porte ALU au naturel avec revêtement ALU laqué noir
Porte ALU naturale e rivestimento ALU verniciato nero

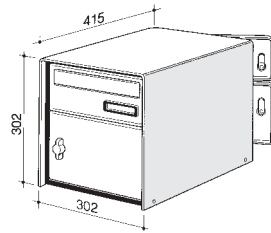

Mod. 38-472.72
Türen ALU natur und Verkleidung ALU natur
Porte ALU au naturel et revêtement en ALU au naturel
Porte ALU naturale e rivestimento ALU naturale
Mod. 38-472.76
Türen ALU natur und Verkleidung ALU schwarz lackiert
Porte ALU au naturel avec revêtement ALU laqué noir
Porte ALU naturale e rivestimento ALU verniciato nero

38-272.72 38-272.76 299.-	38-272 RAL + 190.- Netto/net	38-472.76 38-472.72 323.-	38-472 RAL + 240.- Netto/net

39-001.10 29.-	39-090 98.-	31-090.72 240.-	31-090 RAL + 70.- Netto/net

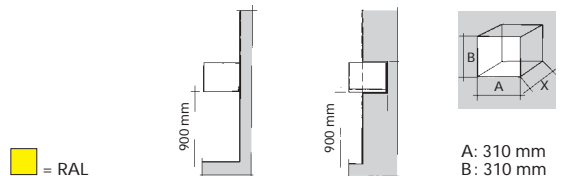

= RAL



Mit Sprechgitter und Klingeltaster / Avec prédisposition pour parlophone / Con predisposizione citofono

= RAL

				A: 304 mm B: 427 mm
660.-	732.-	812.-		
				A: 304 mm B: 727 mm
1015.-	1124.-	1260.-		
				A: 429 mm B: 302 mm
648.-	713.-	793.-		
				A: 729 mm B: 302 mm
979.-	1062.-	1198.-		
				A: 310 mm B: 435 mm
630.-	703.-	784.-		
				A: 310 mm B: 775 mm
1037.-	1146.-	1282.-		
				A: 435 mm B: 310 mm
611.-	676.-	756.-		
				A: 740 mm B: 350 mm
1032.-	1115.-	1250.-		
				A: 320 mm B: 445 mm
566.- *580.-	601.- *622.-	682.- *702.-		
				A: 320 mm B: 745 mm
872.- *886.-	922.- *943.-	1057.- *1079.-		
				A: 445 mm B: 320 mm
566.- *585.-	601.- *629.-	682.- *709.-		
				A: 745 mm B: 320 mm
872.- *891.-	922.- *950.-	1057.- *1084.-		

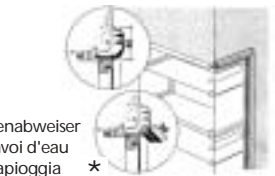
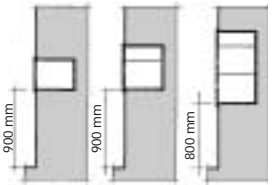
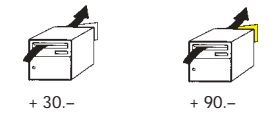
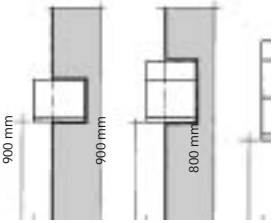
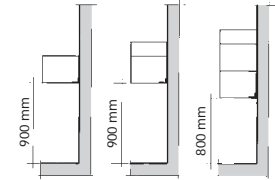

* = Mit Regenabweiser
* = Avec renvoi d'eau
* = Con parapoggia *

Briefkasten / Boîtes aux lettres / Cassette per lettere



Briefkastenanlagen für Teilwandmontage / Groupes pour montage semi-encasté / Gruppi semincassati

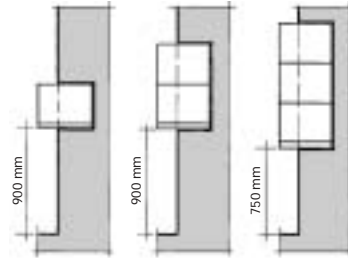
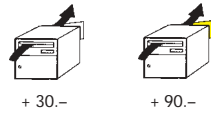

= RAL

								A X B
2	667.-		742.-		852.-			610 x 310 mm
3	1097.-		1190.-		1356.-			910 x 350 mm
2	719.-		812.-		923.-			310 x 650 mm
4	1327.-	1457.-	1440.-	1570.-	1661.-	1790.-		610 x 650 mm
6	1886.-	2059.-	2018.-	2191.-	2350.-	2522.-		910 x 650 mm
8	2444.-	2660.-	2191.-	2810.-	3036.-	3252.-		1210 x 650 mm
10	3002.-	3262.-	3172.-	3431.-	3724.-	4276.-		1510 x 670 mm
6	1889.-	2062.-	2039.-	2212.-	2370.-	2701.-		610 x 950 mm
9	2676.-	2914.-	2845.-	3083.-	3342.-	3839.-		910 x 950 mm
12	3461.-	3763.-	3648.-	3950.-	4310.-	4973.-		1210 x 950 mm
15	4247.-	4614.-	4453.-	4820.-	5281.-	6109.-		1510 x 970 mm

Briefkasten / Boîtes aux lettres / Cassette per lettere



Gruppen für Wandeinbau mit Anputzrahmen / Groupe encastré avec couvre-joint / Gruppo incassato con coprifuga

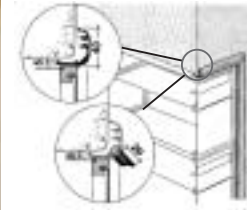

* = Mit Regenabweiser
* = Avec renvoi d'eau
* = Con parapioggia

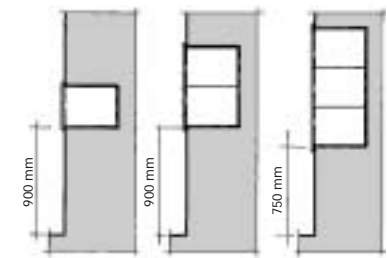

= RAL

								A X B
2	625.- *649.-		667.- *691.-		778.- *802.-			620 x 320 mm
3	910.- *946.-		966.- *1002.-		1132.- *1168.-			920 x 320 mm
2	625.- *637.-		667.- *679.-		778.- *790.-			320 x 620 mm
4	1138.- *1162.-	1267.- *1291.-	1194.- *1218.-	1324.- *1348.-	1415.- *1439.-	1544.- *1568.-		620 x 620 mm
6	1649.- *1686.-	1822.- *1859.-	1720.- *1757.-	1892.- *1929.-	2051.- *2088.-	2224.- *2261.-		920 x 620 mm
8	2161.- *2210.-	2377.- *2426.-	2245.- *2294.-	2461.- *2510.-	2687.- *2736.-	2903.- *2952.-		1220 x 620 mm
10	2674.- *2735.-	2933.- *2994.-	2772.- *2833.-	3031.- *3092.-	3324.- *3385.-	3583.- *3644.-		1520 x 620 mm
6	1649.- *1674.-	1822.- *1847.-	1720.- *1745.-	1892.- *1917.-	2051.- *2076.-	2229.- *2249.-		620 x 920 mm
9	2389.- *2425.-	2627.- *2663.-	2473.- *2509.-	2711.- *2747.-	2970.- *3006.-	3208.- *3244.-		920 x 920 mm
12	3130.- *3179.-	3432.- *3481.-	3228.- *3277.-	3530.- *3579.-	3890.- *3939.-	4193.- *4242.-		1220 x 920 mm
15	3870.- *3931.-	4237.- *4298.-	3983.- *4044.-	4350.- *4411.-	4811.- *4872.-	5178.- *5239.-		1520 x 920 mm

Briefkasten / Boîtes aux lettres / Cassette per lettere



Briefkastenanlagen mit ALU-Ständer / Groupes avec poteaux en aluminium / Gruppi con pali in alluminio



Mit Aluminium Rückwand

Avec revêtement en aluminium à l'arrière

Con schienale in alluminio

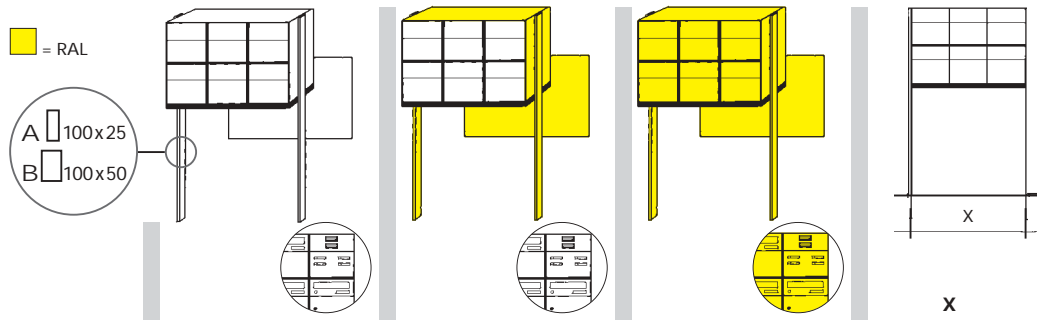
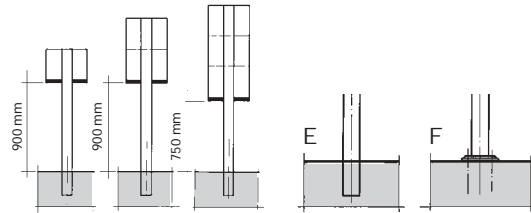

A	2	E: 941.- F: 1008.-		E: 1234.- F: 1259.-	E: 1350.- F: 1375.-		630 mm	
	3	E: 1385.- F: 1444.-		E: 1700.- F: 1726.-	E: 1866.- F: 1891.-		930 mm	
	2	E: 1050.- F: 1108.-		E: 1409.- F: 1420.-	E: 1519.- F: 1530.-		330 mm	
	4	E: 1687.- F: 1745.-	E: 1817.- F: 1874.-	E: 2076.- F: 2087.-	E: 2206.- F: 2216.-	E: 2447.- F: 2458.-	E: 2576.- F: 2587.-	630 mm
	6	E: 2293.- F: 2344.-	E: 2466.- F: 2516.-	E: 2708.- F: 2704.-	E: 2881.- F: 2877.-	E: 3040.- F: 3035.-	E: 3212.- F: 3208.-	930 mm
	8	E: 2879.- F: 2921.-	E: 3095.- F: 3137.-	E: 3341.- F: 3322.-	E: 3557.- F: 3538.-	E: 3782.- F: 3763.-	E: 3998.- F: 3979.-	1230 mm
	10	E: 3473.- F: 3506.-	E: 3732.- F: 3765.-	E: 3972.- F: 3937.-	E: 4231.- F: 4196.-	E: 4524.- F: 4489.-	E: 4783.- F: 4748.-	1530 mm
	6	E: 2318.- F: 2360.-	E: 2448.- F: 2490.-	E: 2789.- F: 2770.-	E: 2918.- F: 2899.-	E: 3120.- F: 3101.-	E: 3250.- F: 3230.-	630 mm
	9	E: 3157.- F: 3191.-	E: 3395.- F: 3428.-	E: 3671.- F: 3636.-	E: 3908.- F: 3874.-	E: 4168.- F: 4134.-	E: 4405.- F: 4370.-	930 mm
	12	E: 4421.- F: 4399.-	E: 4723.- F: 4702.-	E: 5009.- F: 4909.-	E: 5311.- F: 5212.-	E: 5671.- F: 5572.-	E: 5974.- F: 5874.-	1255 mm
	15	E: 5258.- F: 5237.-	E: 5626.- F: 5604.-	E: 5874.- F: 5774.-	E: 6241.- F: 6142.-	E: 6702.- F: 6602.-	E: 7069.- F: 6970.-	1555 mm
	B							

Briefkasten / Boîtes aux lettres / Cassette per lettere



Briefkastenanlagen mit ALU-Ständer und Traverse / Groupes avec poteaux et traverse en aluminium / Gruppi con pali e traversa in alluminio



Mit Aluminium Rückwand

Avec revêtement en aluminium à l'arrière

Con schienale in alluminio

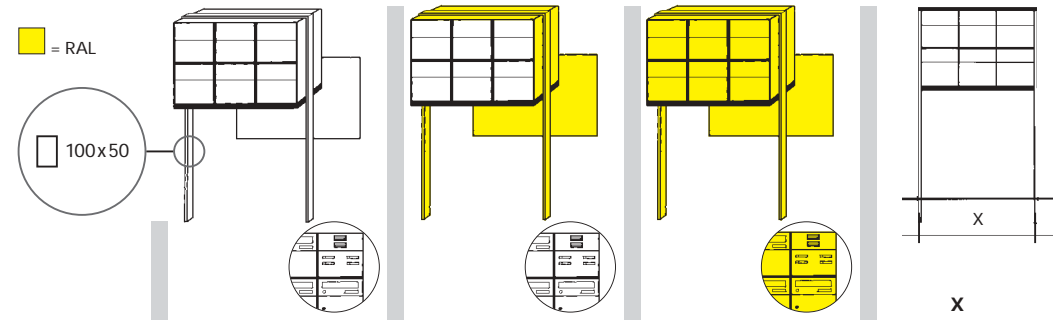
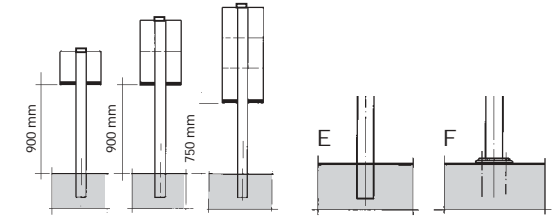

A	2	E: 1418.- F: 1466.-		E: 1813.- F: 1813.-	E: 1956.- F: 1956.-		655 mm	
	3	E: 1907.- F: 1955.-		E: 2345.- F: 2345.-	E: 2510.- F: 2510.-		955 mm	
	2	E: 1547.- F: 1578.-		E: 1993.- F: 1969.-	E: 2104.- F: 2104.-		355 mm	
	4	E: 2228.- F: 2260.-	E: 2358.- F: 2389.-	E: 2725.- F: 2701.-	E: 2855.- F: 2831.-	E: 2946.- F: 2922.-	E: 3076.- F: 3052.-	655 mm
	6	E: 2879.- F: 2892.-	E: 3061.- F: 3074.-	E: 3433.- F: 3384.-	E: 3606.- F: 3557.-	E: 3764.- F: 4915.-	E: 3937.- F: 3888.-	955 mm
	8	E: 3527.- F: 3523.-	E: 3743.- F: 3739.-	E: 4140.- F: 4066.-	E: 4356.- F: 4282.-	E: 4582.- F: 4507.-	E: 4798.- F: 4723.-	1255 mm
	10	E: 4175.- F: 4153.-	E: 4434.- F: 4412.-	E: 4727.- F: 4627.-	E: 4986.- F: 4886.-	E: 5279.- F: 5179.-	E: 5538.- F: 5438.-	1555 mm
	6	E: 2905.- F: 2901.-	E: 3035.- F: 3031.-	E: 3488.- F: 3414.-	E: 3618.- F: 3544.-	E: 3820.- F: 3745.-	E: 3949.- F: 3875.-	655 mm
	9	E: 3798.- F: 3776.-	E: 4036.- F: 4014.-	E: 4445.- F: 4345.-	E: 4682.- F: 4583.-	E: 4942.- F: 4842.-	E: 5179.- F: 5080.-	955 mm
	12	E: 4670.- F: 4649.-	E: 4973.- F: 4951.-	E: 5336.- F: 5273.-	E: 5675.- F: 5575.-	E: 6035.- F: 5935.-	E: 6337.- F: 6237.-	1255 mm
	15	E: 5552.- F: 5531.-	E: 5908.- F: 5886.-	E: 6302.- F: 6203.-	E: 6670.- F: 6570.-	E: 7130.- F: 7030.-	E: 7498.- F: 7398.-	1555 mm
	B							